

CMOS 12-STAGE BINARY COUNTER

FEATURES



- ◆ 12 Fully Static Stages
- ◆ All 12 Buffered Outputs Available
- ◆ Common Reset Line
- ◆ 8MHz Counting Rate @ 10Vdc
- ◆ All Inputs Buffered

DESCRIPTION

The 4040 B consists of 12-ripple-carry binary counter stages with appropriate input buffers and reset circuitry. The counter is reset to its "all 0's" state by a high level on the Reset input. The counter is advanced one count on the negative-going transition of each input pulse. Isolation from external noise and the effects of loads is provided by output buffering.

Applications include time delay circuits, counter controls, and frequency dividers.

TRUTH TABLE

Clock	Reset	Output State
	0	No Change
	0	Advance to next state
x	1	All Outputs are low

X = Don't Care

CONNECTION DIAGRAM (all packages)

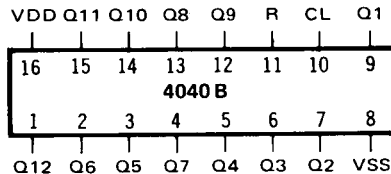

Add suffix for package:

- C 16-pin Cerdip
- D 16-pin Ceramic
- E 16-pin Epoxy
- F 16-pin Flat
- H Chip

RECOMMENDED OPERATING CONDITIONS

For maximum reliability:

DC Supply Voltage $V_{DD} - V_{SS}$ 3 to 15 Vdc

Operating Temperature T_A

C, D, F, H Device -55 to +125 °C

E Device -40 to +85 °C

LOGIC DIAGRAM

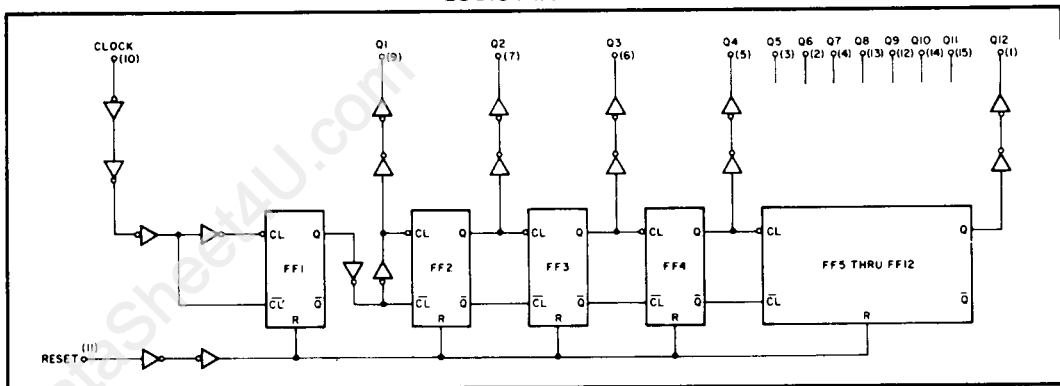

ELECTRICAL CHARACTERISTICS

STATIC CHARACTERISTICS¹

PARAMETER	V _{DD} (Vdc)	CONDITIONS	T _{LOW} ²		+25°C			T _{HIGH} ²		Units
			Min.	Max.	Min.	Typ.	Max.	Min.	Max.	
QUIESCENT DEVICE CURRENT	I _{DD}	V _{IN} =V _{SS} or V _{DD} All valid input combinations	–	5	–	0.05	5	–	150	μA _{dc}
			–	10	–	0.1	10	–	300	
			–	15	–	0.2	20	–	600	

NOTES: ¹ Remaining Static Electrical Characteristics are listed under "4000B Series Family Specifications".

² T_{LOW} = -55°C for C, D, F, H device.

= -40°C for E device.

T_{HIGH} = +125°C for C, D, F, H device.

= + 85°C for E device.

DYNAMIC CHARACTERISTICS (C_L = 50pF, T_A = 25°C)

PARAMETER		V _{DD} (Vdc)	Min.	Typ.	Max.	Units
CLOCKED OPERATION						
PROPAGATION DELAY TIME Clock to Q1	t _{PLH} , t _{PHL}	5	–	180	320	ns
		10	–	80	160	
		15	–	65	130	
Q _i to Q _{i+1}	t _{PLH} , t _{PHL}	5	–	100	200	ns
		10	–	40	60	
		15	–	30	30	
OUTPUT TRANSITION TIME	t _{TLH} , t _{THL}	5	–	100	200	ns
		10	–	40	80	
		15	–	30	60	
MINIMUM CLOCK PULSE WIDTH	PW _{CL}	5	–	70	140	ns
		10	–	30	60	
		15	–	20	40	
MAXIMUM CLOCK FREQUENCY	f _{CL}	5	3.0	4.5	–	MHz
		10	6.0	9.0	–	
		15	7.5	11.0	–	
MAXIMUM CLOCK RISE AND FALL TIME	t _{rCL} , t _{fCL}	5	50	100	–	μs
		10	50	100	–	
		15	50	100	–	
RESET OPERATION						
PROPAGATION DELAY TIME	t _{PHL}	5	–	200	400	ns
		10	–	100	200	
		15	–	75	150	
MINIMUM RESET PULSE WIDTH	PW _R	5	–	100	200	ns
		10	–	40	80	
		15	–	30	60	
RESET REMOVAL TIME	t _{rem}	5	–	150	300	ns
		10	–	65	125	
		15	–	40	75	

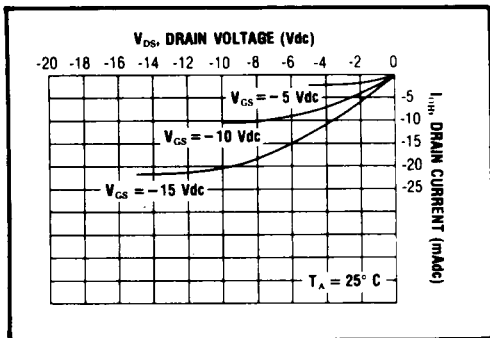

Typical P-Channel Source Current Characteristics

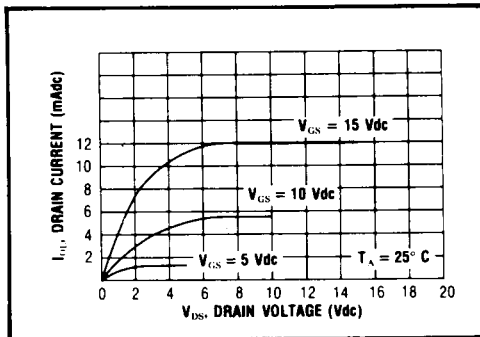

Typical N-Channel Sink Current Characteristics

TIMING DIAGRAM

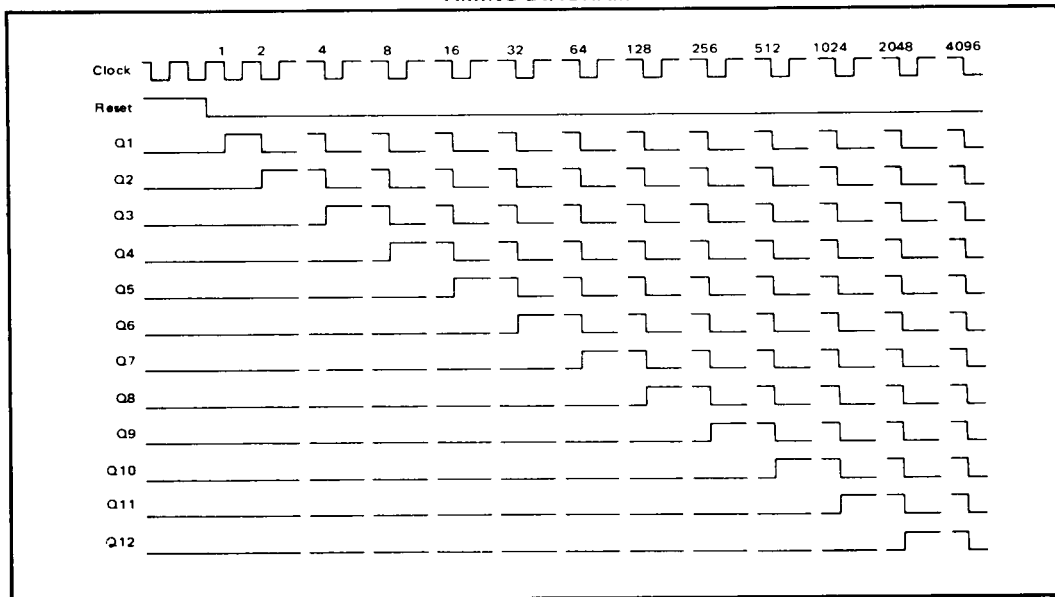

TYPICAL COUNTER STAGE

